

SMD Power Inductor CDRH4D28



Description

- Ferrite drum core construction.
- Magnetically shielded.
- L × W × H: 5.0 × 5.0 × 3.0 mm Max.
- Product weight: 0.2g(Ref.)
- Moisture Sensitivity Level: 1
- RoHS compliance.

Environmental Data

- Operating temperature range: -40°C ~ +100°C (including coil's self temperature rise)
- Storage temperature range: -40°C ~ +100°C
- Solder reflow temperature: 260 °C peak.

Packaging

- Carrier tape and reel packaging
- 12.9" diameter reel
- 2000pcs per reel

Applications

- Ideally used in Mobile phone, PDA, MP3, HDD, DSC/DVC, Note book PC, etc as DC-DC converter inductors.

Dimension - [mm]

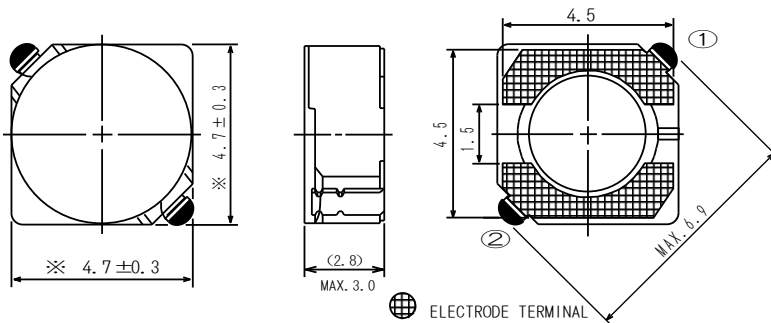

Land pattern and Schematics - [mm]

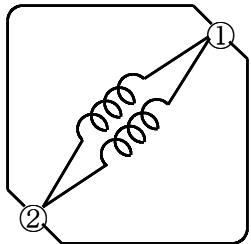
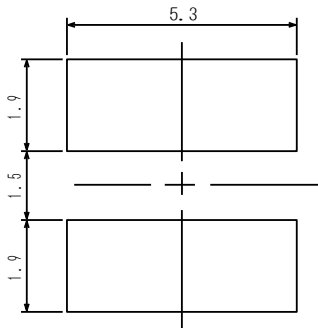

(1.2μH ~ 8.2μH)

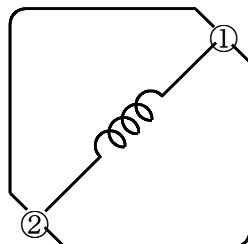

(10μH ~ 180μH)

SMD Power Inductor

CDRH4D28



Electrical Characteristics

| Part No. | Stamp | Inductance (μH) [within] ※1 | D.C.R.(Ω) Max. (Typ.) (at 20°C) | Rated Current (A) ※2 |
|------------------|-------|--|--|-------------------------|
| CDRH4D28NP-1R2NC | 1R2 | 1.2 \pm 30% | 23.6m(17.5m) | 2.56 |
| CDRH4D28NP-1R8NC | 1R8 | 1.8 \pm 30% | 27.5m(20.4m) | 2.20 |
| CDRH4D28NP-2R2NC | 2R2 | 2.2 \pm 30% | 31.3m(23.2m) | 2.04 |
| CDRH4D28NP-2R7NC | 2R7 | 2.7 \pm 30% | 43.3m(32.1m) | 1.60 |
| CDRH4D28NP-3R3NC | 3R3 | 3.3 \pm 30% | 49.2m(36.4m) | 1.57 |
| CDRH4D28NP-3R9NC | 3R9 | 3.9 \pm 30% | 64.8m(48.0m) | 1.44 |
| CDRH4D28NP-4R7NC | 4R7 | 4.7 \pm 30% | 72.0m(53.3m) | 1.32 |
| CDRH4D28NP-5R6NC | 5R6 | 5.6 \pm 30% | 100.9m(74.7m) | 1.17 |
| CDRH4D28NP-6R8NC | 6R8 | 6.8 \pm 30% | 108.9m(80.7m) | 1.12 |
| CDRH4D28NP-8R2NC | 8R2 | 8.2 \pm 30% | 117.5m(87.0m) | 1.04 |
| CDRH4D28NP-100NC | 100 | 10 \pm 30% | 128.3m(95.0m) | 1.00 |
| CDRH4D28NP-120NC | 120 | 12 \pm 30% | 131.6m(97.5m) | 0.84 |
| CDRH4D28NP-150NC | 150 | 15 \pm 30% | 149.0m(110.4m) | 0.76 |
| CDRH4D28NP-180NC | 180 | 18 \pm 30% | 166.0m(123.0m) | 0.72 |
| CDRH4D28NP-220NC | 220 | 22 \pm 30% | 235.0m(174.5m) | 0.70 |
| CDRH4D28NP-270NC | 270 | 27 \pm 30% | 261.0m(193.3m) | 0.58 |
| CDRH4D28NP-330NC | 330 | 33 \pm 30% | 331.3m(254.8m) | 0.56 |
| CDRH4D28NP-390NC | 390 | 39 \pm 30% | 383.7m(284.2m) | 0.50 |
| CDRH4D28NP-470NC | 470 | 47 \pm 30% | 587.0m(435.0m) | 0.48 |
| CDRH4D28NP-560NC | 560 | 56 \pm 30% | 624.5m(462.6m) | 0.41 |
| CDRH4D28NP-680NC | 680 | 68 \pm 30% | 699.0m(517.8m) | 0.35 |
| CDRH4D28NP-820NC | 820 | 82 \pm 30% | 914.8m(677.6m) | 0.32 |
| CDRH4D28NP-101NC | 101 | 100 \pm 30% | 1.02(765.8m) | 0.29 |
| CDRH4D28NP-121NC | 121 | 120 \pm 30% | 1.27(976.8m) | 0.27 |
| CDRH4D28NP-151NC | 151 | 150 \pm 30% | 1.35(1.08) | 0.24 |
| CDRH4D28NP-181NC | 181 | 180 \pm 30% | 1.54(1.23) | 0.22 |

※1. Inductance measuring condition: at 100kHz.

※2. Rated current: The DC current at which the inductance decreases to 65% of its nominal value or when $\Delta t=40^\circ\text{C}$, whichever is lower ($T_a=20^\circ\text{C}$).

SMD Power Inductor CDRH4D28



Saturation Current & Temperature Rise Graph

— L (20°C) — L (100°C) — ΔT

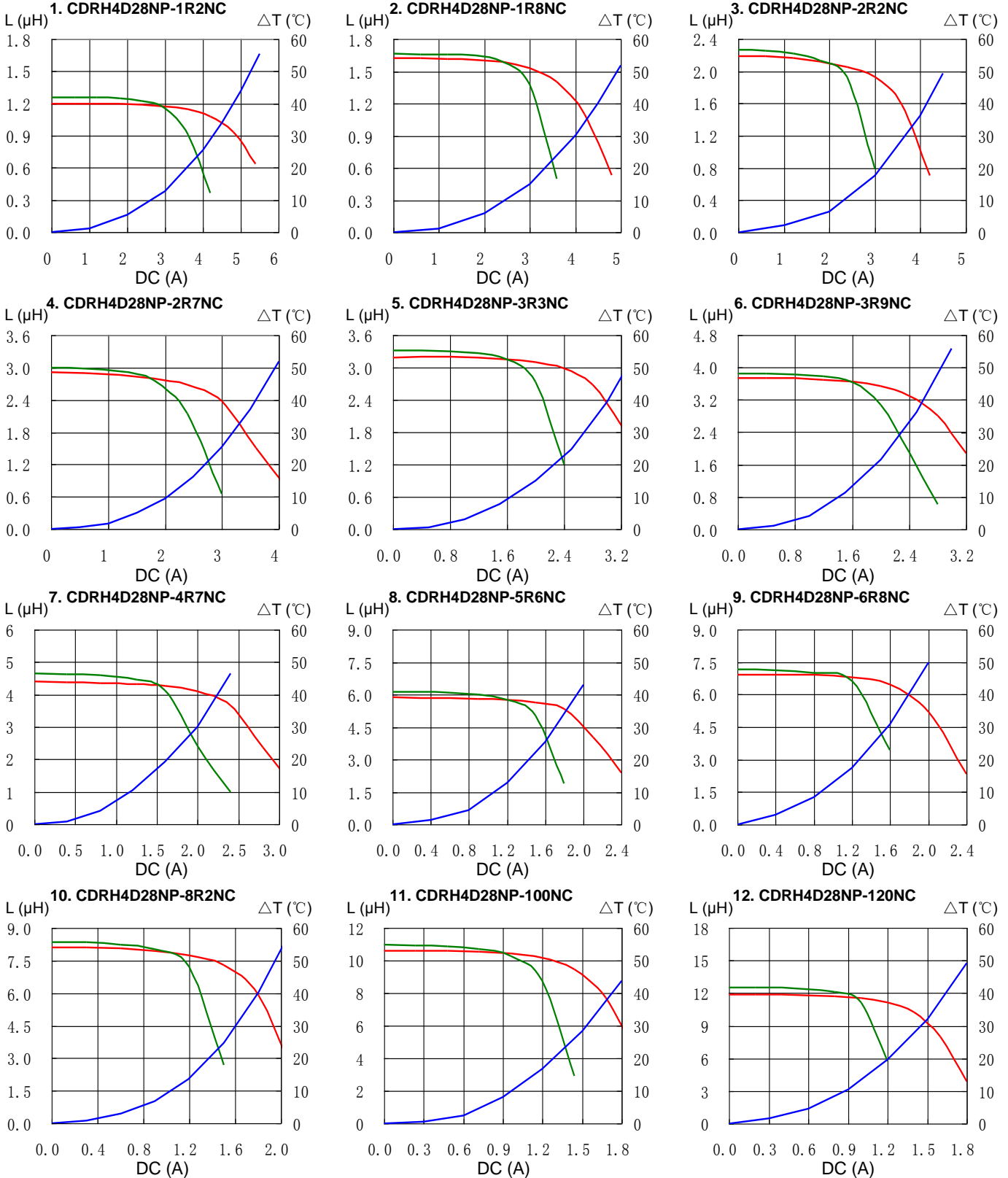

SMD Power Inductor CDRH4D28



Saturation Current & Temperature Rise Graph

— L (20°C) — L (100°C) — ΔT

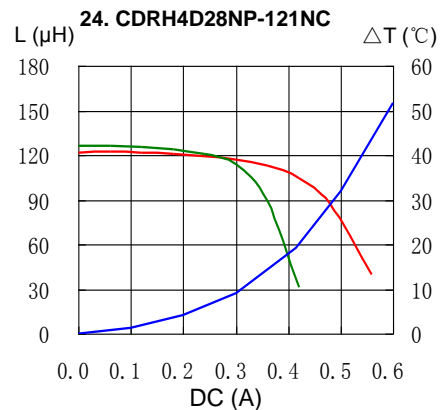
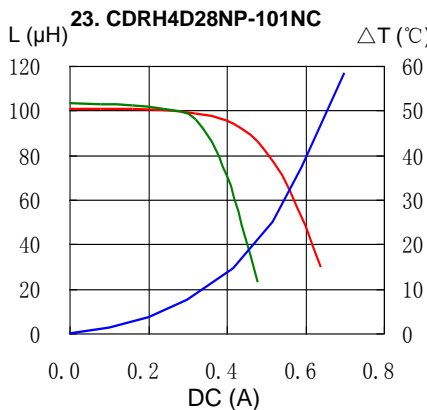
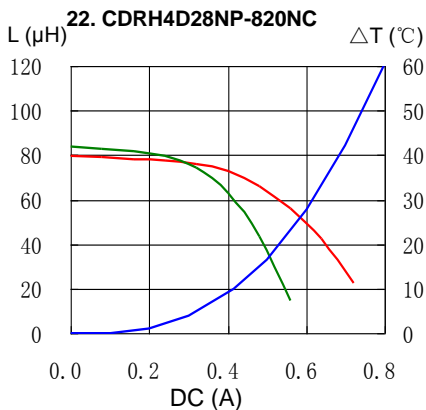
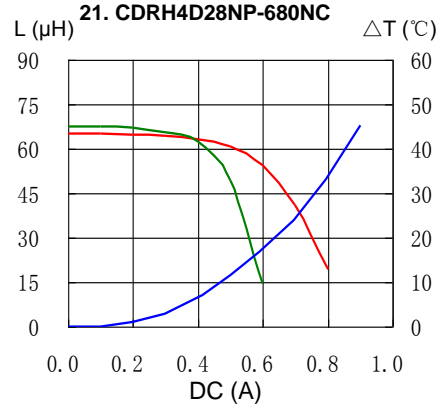
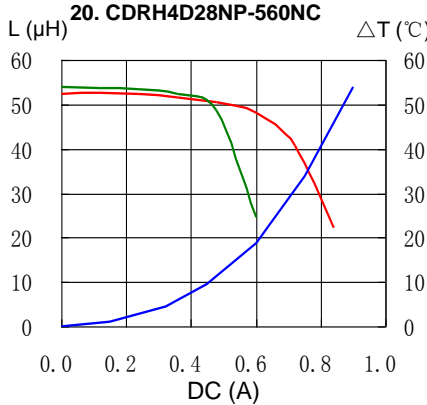
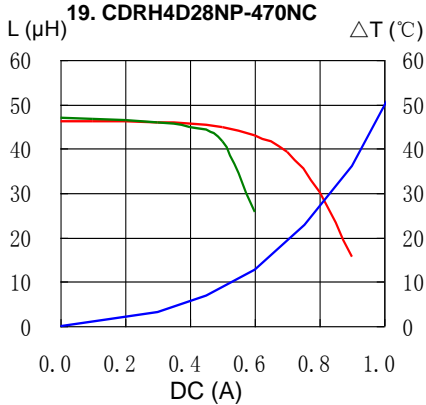
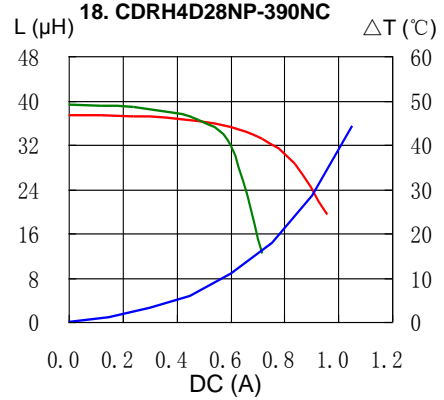
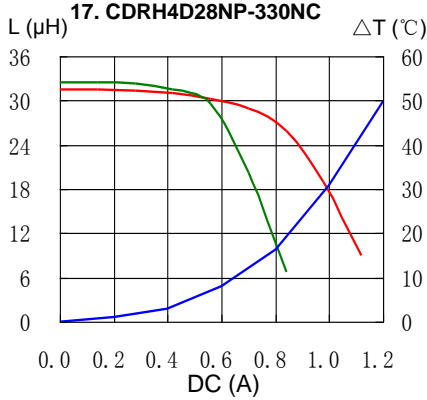
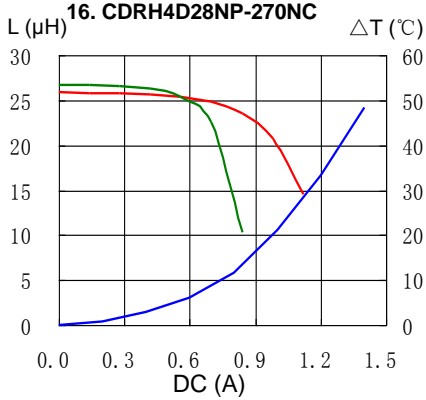
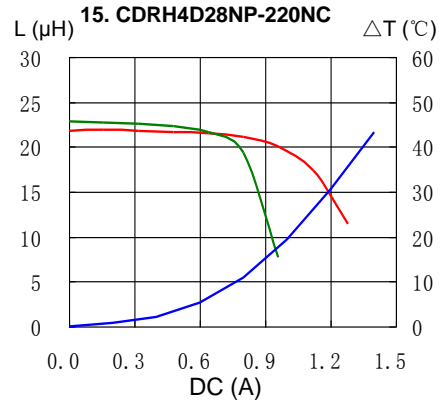
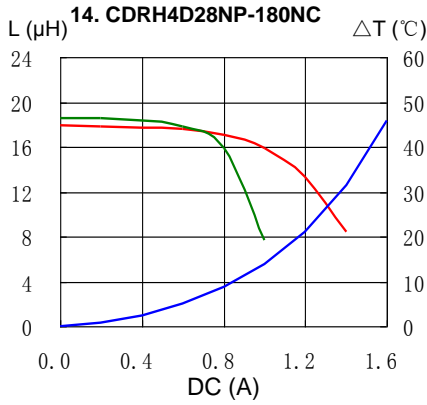
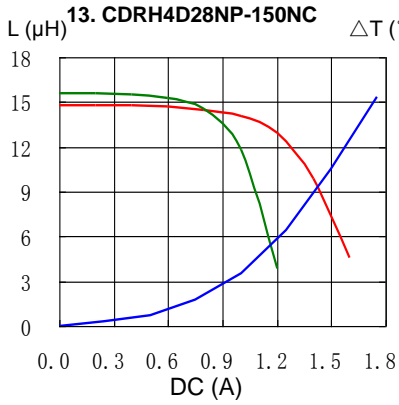

SMD Power Inductor CDRH4D28



Saturation Current & Temperature Rise Graph

— L (20°C) — L (100°C) — ΔT

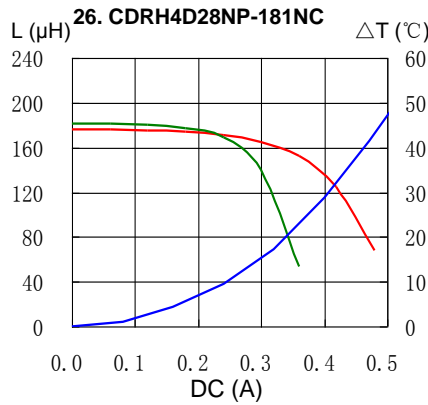
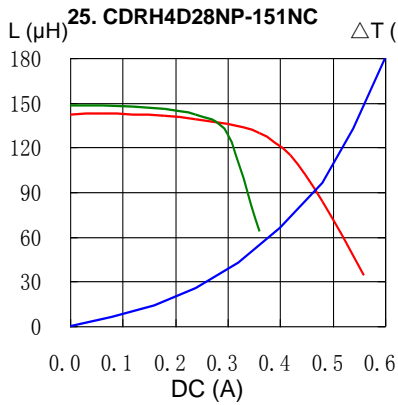

Solder Reflow Condition

Heat Endurance

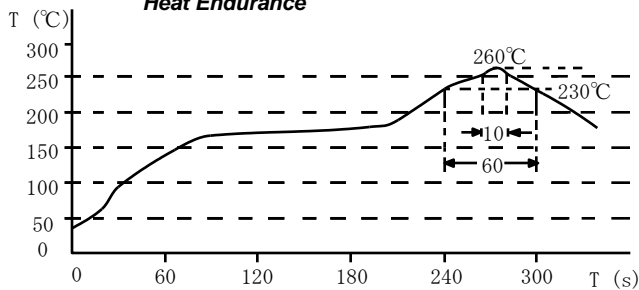

Temperature Chart

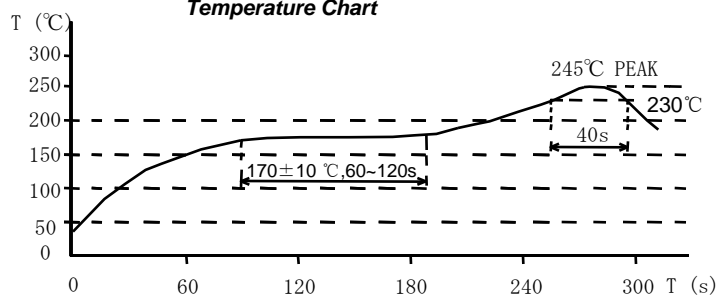

Please refer to the sales offices on our website - <http://www.sumida.com>

Hong Kong

Tel.+852-2880-6781
FAX.+852-2565-9600
sales@hk.sumida.com

Saitama(Japan)

Tel.+81-48-691-7300
FAX.+81-48-691-7340
sales@jp.sumida.com

Chicago

Tel.+1-847-545-6700
FAX. +1-847-545-6720
sales@us.sumida.com

Shanghai

Tel.+86-21-5836-3299
FAX.+86-21-5836-3266
shanghai.sales@cn.sumida.com

Seoul

Tel.+82-2-6237-0777
FAX.+82-2-6237-0778
sales@kr.sumida.com

Obernzell

Tel.+49-8591-937-0
FAX. +49-8591-937-103
contact@eu.sumida.com

Shenzhen

Tel.+86-755-8291-0228
FAX.+86-755-8291-0338
shenzhen.sales@cn.sumida.com

Singapore

Tel.+65-6296-3388
FAX.+65-6841-4426
sales@sg.sumida.com

Neumarkt

Tel.+49-9181-4509-110
FAX. +49-9181-4509-310
infocomp@eu.sumida.com

Taipei

Tel.+886-2-8751-2737
FAX.+886-2-8751-2738
sales@tw.sumida.com

San Jose

Tel.+1-408-321-9660
FAX.+1-408-321-9308
sales@us.sumida.com

Mouser Electronics

Authorized Distributor

Click to View Pricing, Inventory, Delivery & Lifecycle Information:

Sumida:

[CDRH4D28NP-2R2NC](#) [CDRH4D28NP-6R8NC](#) [CDRH4D28NP-100NC](#) [CDRH4D28NP-330NC](#) [CDRH4D28NP-101NC](#) [CDRH4D28NP-390NC](#) [CDRH4D28NP-8R2NC](#) [CDRH4D28NP-2R7NC](#) [CDRH4D28NP-121NC](#) [CDRH4D28NP-1R2NC](#) [CDRH4D28NP-680NC](#) [CDRH4D28NP-470NC](#) [CDRH4D28NP-820NC](#) [CDRH4D28NP-151NC](#) [CDRH4D28NP-1R8NC](#) [CDRH4D28NP-3R3NC](#) [CDRH4D28NP-270NC](#) [CDRH4D28NP-150NC](#) [CDRH4D28NP-180NC](#) [CDRH4D28NP-5R6NC](#) [CDRH4D28NP-120NC](#) [CDRH4D28NP-560NC](#) [CDRH4D28NP-181NC](#) [CDRH4D28NP-3R9NC](#)