

MAX40203

Ultra-Tiny nanoPower, 1A Ideal Diodes with Ultra-Low-Voltage Drop

General Description

The MAX40203 is an ideal diode current-switch with forward voltage drop that is approximately an order of magnitude smaller than that of Schottky diodes. When forward biased and enabled, the MAX40203 conducts with 90mV of voltage drop while carrying currents as high as 1A. During a short-circuit or a fast power-up, the device limits its output current to 2A. The MAX40203 thermally protects itself and any downstream circuitry from overcurrent conditions.

This ideal diode operates from a supply voltage of 1.2V to 5.5V. The supply current is relatively constant with load current, and is typically 300nA. When disabled (EN = low), the ideal diode blocks voltages up to 6V in either direction, makes it suitable for use in most low-voltage, portable electronic devices.

The MAX40203 is available in a tiny, 0.77mm x 0.77mm, 4-bump WLP with a 0.35mm bump pitch and a 5-pin SOT23 package. It is specified over the -40°C to +125°C automotive temperature range.

Benefits and Features

- Lower Voltage Drop in Portable Applications
 - 14mV Forward Drop at 1mA (WLP)
 - 16mV Forward Drop at 100mA (WLP)
 - 43mV Forward Drop at 500mA (WLP)
 - 90mV Forward Drop at 1A (WLP)
- Longer Battery Life
 - Low Leakage When Reverse-Biased from V_{DD}
 - 10nA (typ)
 - Low Supply Quiescent Current
 - 300nA (typ), 500nA (max)
- Smaller Footprint Than Larger Schottky Diodes
 - Tiny, 0.77mm x 0.77mm, 4-Bump WLP
 - 5-Pin SOT23 Package
- Wide Supply Voltage Range: 1.2V to 5.5V
- Thermally Self-Protecting
- -40°C to +125°C Operating Temperature Range

Ordering Information appears at end of data sheet.

Applications

- Notebook and Tablet Computers
- Battery Backup Systems
- Powerline Fault Recorders
- Cellular Phones
- Electronic Toys
- USB-Powered Peripherals
- Portable Medical Devices

Simplified Block Diagram

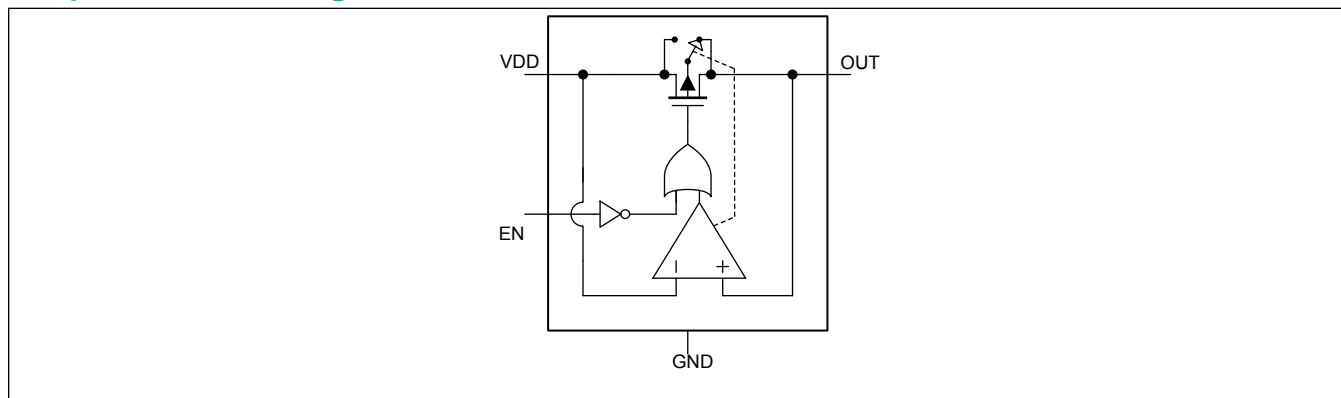

Absolute Maximum Ratings

Any Pin to GND	-0.3V to +6V	Continuous Power Dissipation (T _A = +70°C)	
Continuous Current into EN	10mA	(SOT, derate 3.90mW/°C above +70°C)	312.60mW
Continuous Current Flowing		Operating Temperature Range	-40°C to +125°C
Between V _{DD} and OUT (WLP)	1.5A	Junction Temperature	+150°C
Continuous Current Flowing		Storage Temperature Range	-60°C to +165°C
Between V _{DD} and OUT (SOT).....	1A	Lead Temperature (soldering, 10s).....	+300°C
Continuous Power Dissipation (T _A = +70°C)		Soldering Temperature (reflow)	+260°C
(WLP, derate 9.58mW/°C above +70°C).....	766mW		

Stresses beyond those listed under "Absolute Maximum Ratings" may cause permanent damage to the device. These are stress ratings only, and functional operation of the device at these or any other conditions beyond those indicated in the operational sections of the specifications is not implied. Exposure to absolute maximum rating conditions for extended periods may affect device reliability.

Package Information

4 WLP

Package Code	N40F0+1
Outline Number	21-100273
Land Pattern Number	Refer to Application Note 1891
THERMAL RESISTANCE, FOUR-LAYER BOARD	
Junction to Ambient (θ _{JA})	104.41°C/W
Junction to Case (θ _{JC})	N/A

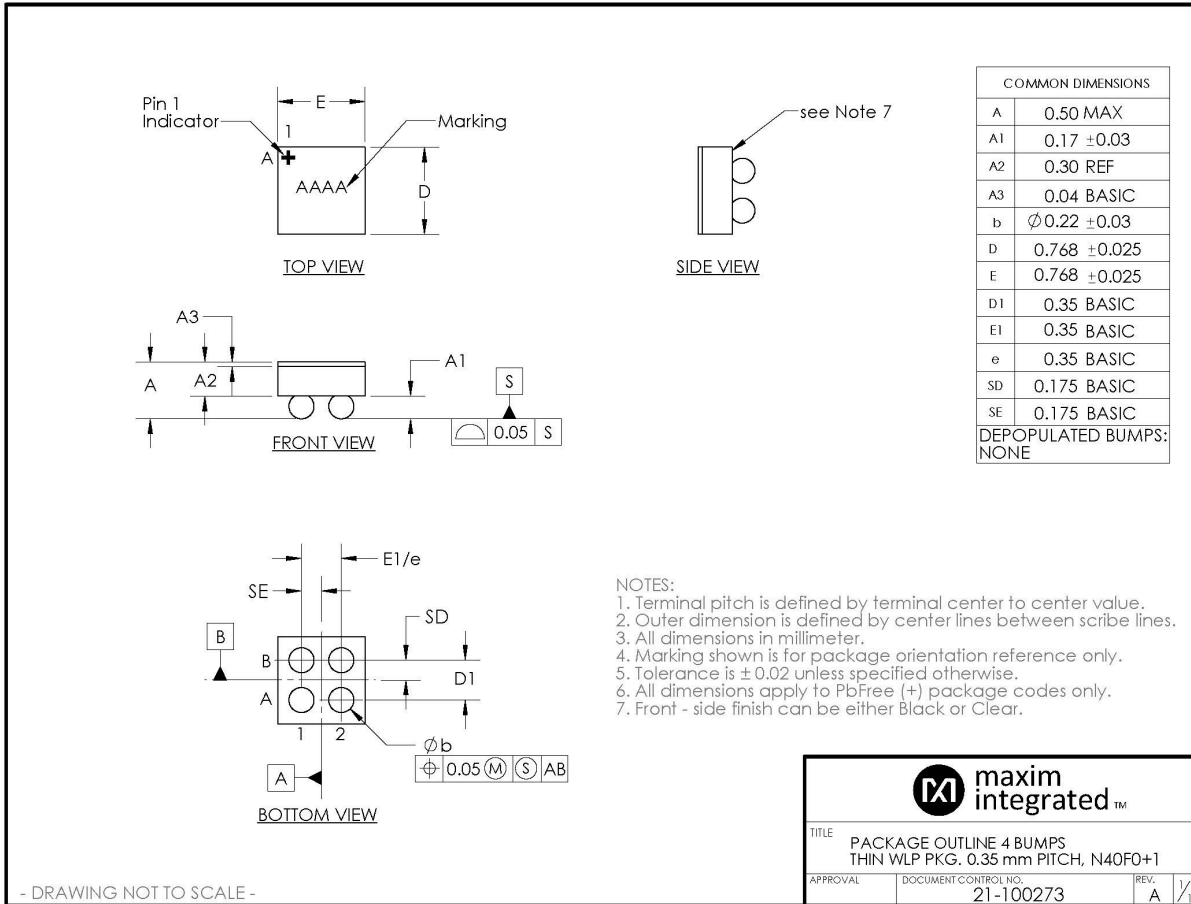

5 SOT23

Package Code	U5+2
Outline Number	21-0057
Land Pattern Number	90-0174
THERMAL RESISTANCE, FOUR-LAYER BOARD	
Junction to Ambient (θ_{JA})	255.90°C/W
Junction to Case (θ_{JC})	81°C/W

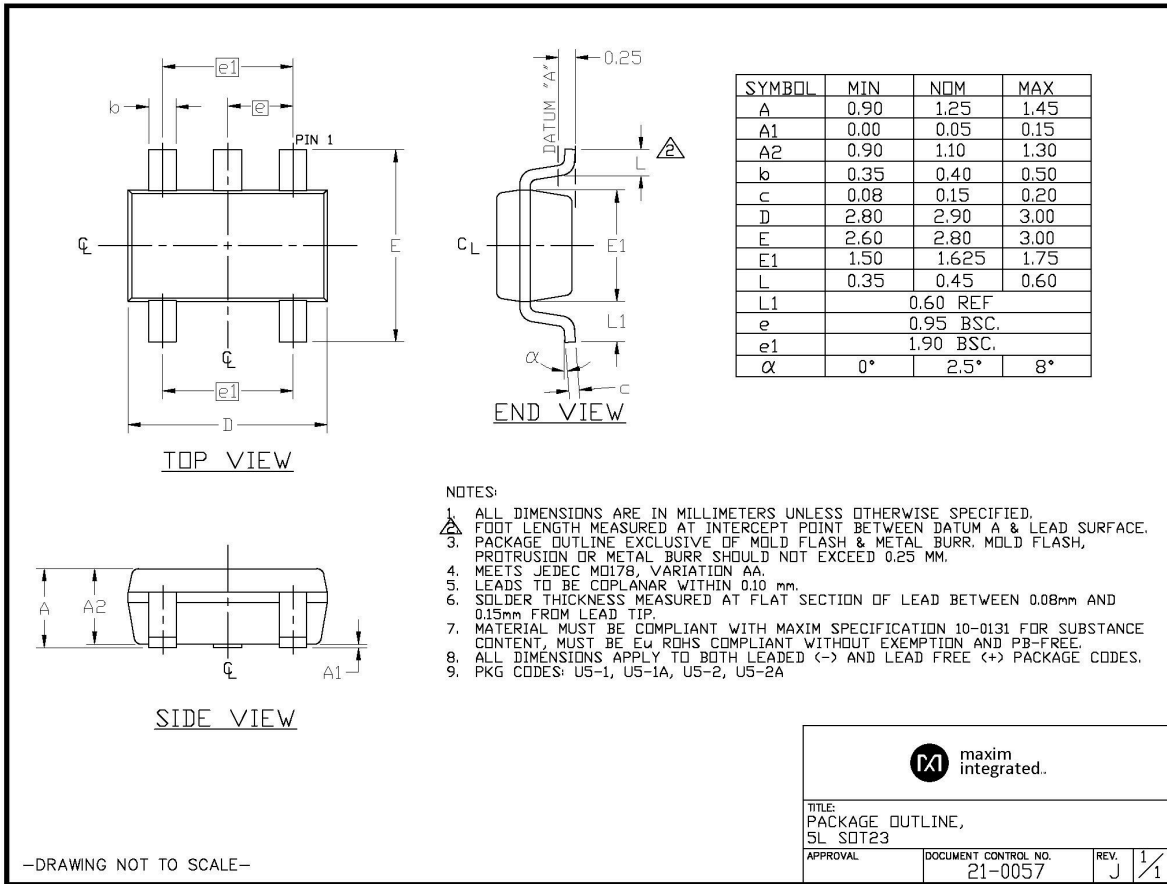

For the latest package outline information and land patterns (footprints), go to www.maximintegrated.com/packages. Note that a "+", "#", or "-" in the package code indicates RoHS status only. Package drawings may show a different suffix character, but the drawing pertains to the package regardless of RoHS status.

Package thermal resistances were obtained using the method described in JEDEC specification JESD51-7, using a four-layer board. For detailed information on package thermal considerations, refer to www.maximintegrated.com/thermal-tutorial.

Electrical Characteristics

($V_{DD} = +3.6V$, $V_{EN} = V_{DD}$, $C_{IN} = 0.1\mu F$ in parallel with $10\mu F$, $C_L = 10\mu F$, $T_A = -40^\circ C$ to $+125^\circ C$. Typical values are at $T_A = +25^\circ C$, unless otherwise noted. (Notes 1, 2))

PARAMETER	SYMBOL	CONDITIONS	MIN	TYP	MAX	UNITS
FORWARD-BIASED CHARACTERISTICS						
Supply Voltage		Guaranteed by V_{FWD} at 100mA	1.2		5.5	V

Electrical Characteristics (continued)

($V_{DD} = +3.6V$, $V_{EN} = V_{DD}$, $C_{IN} = 0.1\mu F$ in parallel with $10\mu F$, $C_L = 10\mu F$, $T_A = -40^\circ C$ to $+125^\circ C$. Typical values are at $T_A = +25^\circ C$, unless otherwise noted. (Notes 1, 2))

PARAMETER	SYMBOL	CONDITIONS	MIN	TYP	MAX	UNITS	
Supply Current (Forward Biased, Enabled)	I_{AG}	No load current ($I_C = 0$), $T_A = +25^\circ C$		300	500	nA	
		No load current ($I_C = 0$) $-40^\circ C < T_A < +85^\circ C$			650		
		No load current ($I_C = 0$), $-40^\circ C < T_A < +125^\circ C$				1.2	μA
Supply Current (Forward Biased, Disabled)		$-40^\circ C < T_A < +85^\circ C$, $V_{EN} = 0V$, $V_{OUT} = 0V$		130	600	nA	
		$-40^\circ C < T_A < +125^\circ C$, $V_{EN} = 0V$, $V_{OUT} = 0V$		130	2000		
Forward Voltage ($V_{DD} - V_{OUT}$)(WLP Only)	V_{FWD}	$I_{FWD} = 1mA$		14	35	mV	
		$I_{FWD} = 100mA$		16	35		
		$I_{FWD} = 200mA$, $V_{DD} = 1.5V$		52	75		
		$I_{FWD} = 200mA$, $V_{DD} = 3.6V$		21	40		
		$I_{FWD} = 500mA$		43	90		
		$I_{FWD} = 1A$ (Note 3)		90	200		
Forward Voltage ($V_{DD} - V_{OUT}$) (SOT23 Only)	V_{FWD}	$I_{FWD} = 1mA$		14	35	mV	
		$I_{FWD} = 100mA$		28	70		
		$I_{FWD} = 200mA$, $V_{DD} = 1.5V$		69	120		
		$I_{FWD} = 200mA$, $V_{DD} = 3.6V$		41	90		
		$I_{FWD} = 500mA$		100	200		
		$I_{FWD} = 1A$ (Note 3)		230	500		
Capacitive Loading		Stable for all load currents (see Applications Information section for further details)		0.3–100		μF	
Thermal Protection Threshold		Device temperature at which the MOSFET switch turns off, overriding the Enable pin and the applied voltage polarity		163		$^\circ C$	
Thermal Protection Hysteresis				14		$^\circ C$	
REVERSE-BIASED CHARACTERISTICS							
Turn-Off Reverse Threshold		$(V_{OUT} - V_{DD})$		26		mV	
Leakage Current from V_{DD} (Reverse Biased)	I_{CA}	$V_{OUT} = 4V$	$T_A = +25^\circ C$	-50	+10	+50	nA
			$-40^\circ C < T_A < +85^\circ C$	-150		+150	
		$V_{OUT} = 5V$	$T_A = +25^\circ C$		15	100	μA
			$-40^\circ C < T_A < +125^\circ C$	-0.5		+0.5	
		$V_{DD} = 2.0V$, $V_{OUT} = 5.5V$, $-40^\circ C < T_A < +85^\circ C$		15	200	nA	

Electrical Characteristics (continued)

($V_{DD} = +3.6V$, $V_{EN} = V_{DD}$, $C_{IN} = 0.1\mu F$ in parallel with $10\mu F$, $C_L = 10\mu F$, $T_A = -40^\circ C$ to $+125^\circ C$. Typical values are at $T_A = +25^\circ C$, unless otherwise noted. (Notes 1, 2))

PARAMETER	SYMBOL	CONDITIONS		MIN	TYP	MAX	UNITS
Current into OUT (Reverse Biased)	I_C	$V_{OUT} = 4V$	$T_A = +25^\circ C$		350	900	nA
			$-40^\circ C < T_A < +85^\circ C$			1400	
		$V_{OUT} = 5V$	$T_A = +25^\circ C$		360	900	
			$-40^\circ C < T_A < +85^\circ C$		700	1400	
Leakage Current into V_{DD} (Reverse Biased, Disabled)	I_{AG}	$V_{EN} = 0V$, $V_{OUT} = 4V$	$T_A = +25^\circ C$	-100	+10	+100	nA
			$-40^\circ C < T_A < +85^\circ C$	-150		+150	
		$V_{EN} = 0V$, $V_{OUT} = 5V$	$T_A = +25^\circ C$	-100	10	+100	
			$-40^\circ C < T_A < +125^\circ C$	-500		+500	
ENABLE (EN)							
Low Level Input Current	I_{AE}	$V_{EN} = 0V$ (Note 2)	$T_A = +25^\circ C$		15	50	nA
			$-40^\circ C < T_A < 125^\circ C$			0.1	μA
Low Input Voltage Level	V_{IL}					0.4	V
High Input Voltage Level	V_{IH}			1.25			V
High Level Input Current	I_{EG}	$V_{EN} = 3.6V$ (Note 2)	$T_A = +25^\circ C$			80	nA
High Level Input Current ($V_{EN} > V_{DD}$)	I_{EG}	$V_{EN} = 5V$ (Note 2)	$T_A = +25^\circ C$		750		nA
			$-40^\circ C < T_A < +125^\circ C$			1300	
Enable Input Hysteresis				10		350	mV
TRANSIENTS AND TIMINGS							
Power-Up Delay					450		μs
Enable Time		Measured from $V_{EN} = V_{DD}$ to the forward current reaching 90% of its final value			320		μs
Disable Time		Load current prior to disabling is 100mA, time measured from $V_{EN} = 0$ until output current $< 1mA$			80		μs

Note 1: Limits are 100% tested at $T_A = +25^\circ C$. Limits over the operating temperature range and relevant supply voltage range are guaranteed by design and characterization.

Note 2: Refer to the Supply and Leakage Current Naming Conventions in the [Detailed Description](#) section for all the different currents that are specified in the [Electrical Characteristics](#) Table.

Note 3: 1A pulsed current in duty cycle used for this test to make sure the device's self heating is negligible. For more information, see [Thermal Performance and Power Dissipation](#) section.

Typical Operating Characteristics

($V_{DD} = 3.6V$, $GND = 0V$, $EN = V_{DD}$, $I_{LOAD} = 100mA$, $C_{OUT} = 10\mu F$ to GND. Typical values are at $T_A = +25^\circ C$, unless otherwise noted.)

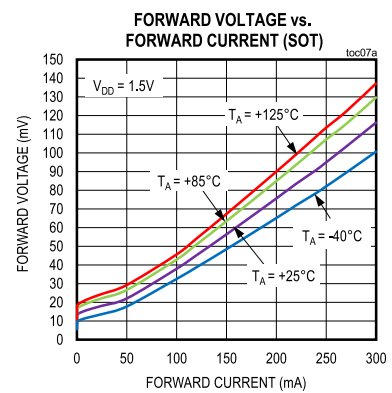
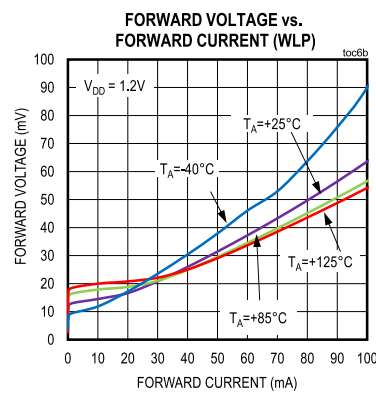
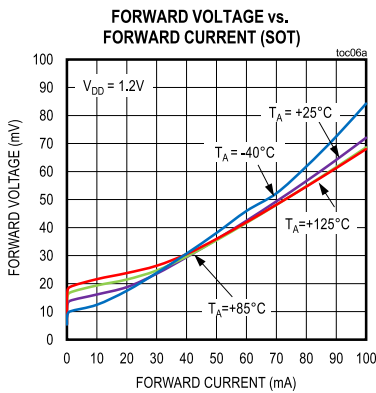
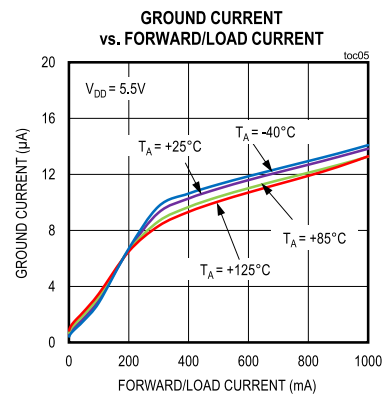
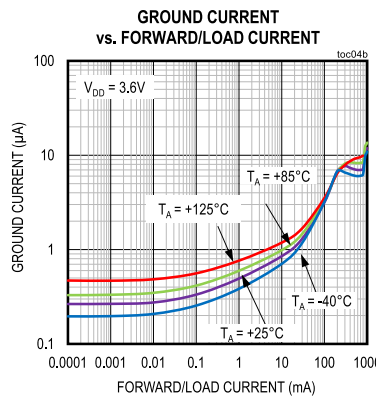
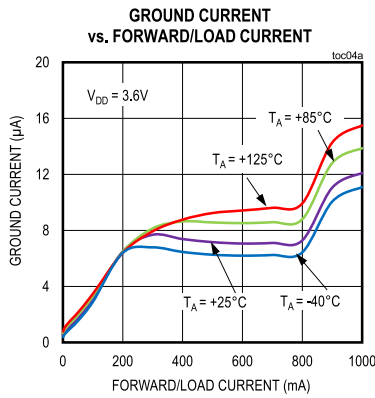
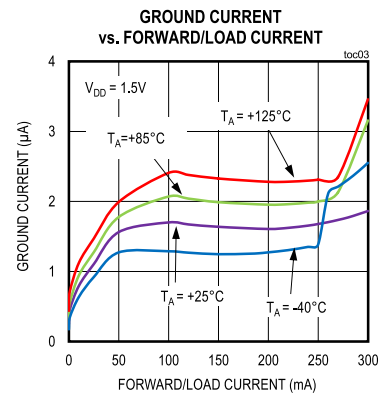
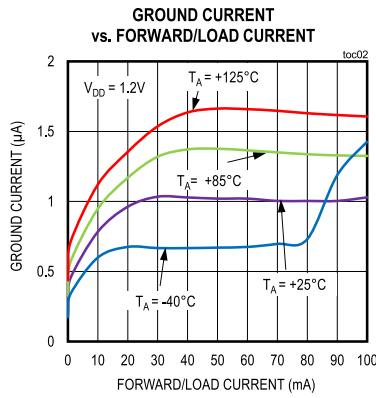
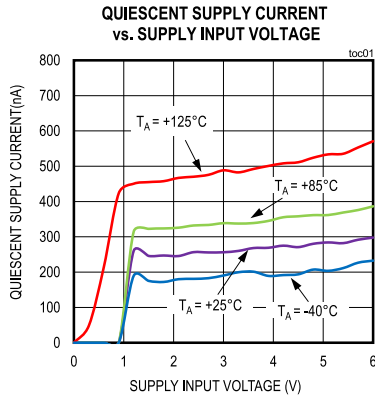

Typical Operating Characteristics (continued)

($V_{DD} = 3.6V$, $GND = 0V$, $EN = V_{DD}$, $I_{LOAD} = 100mA$, $C_{OUT} = 10\mu F$ to GND . Typical values are at $T_A = +25^\circ C$, unless otherwise noted.)

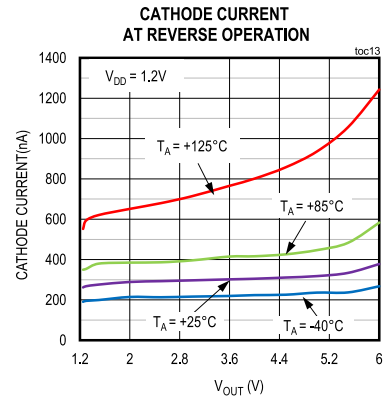
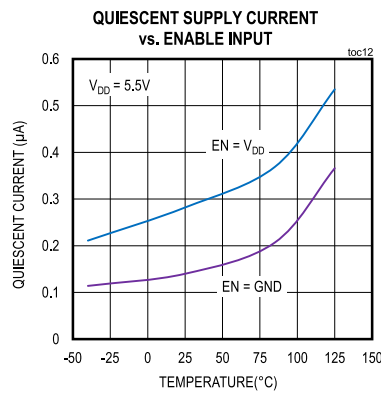
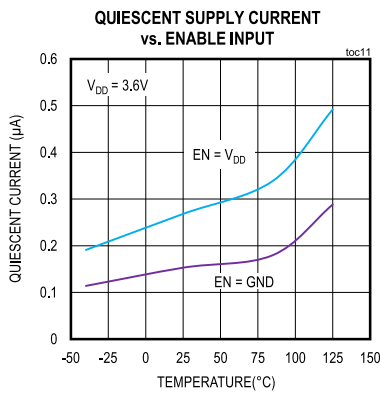
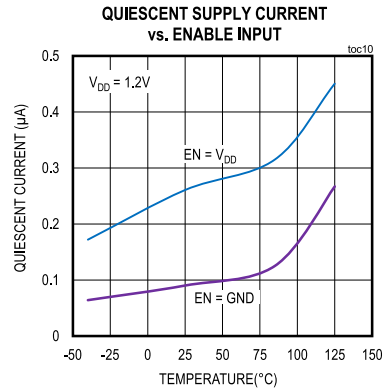
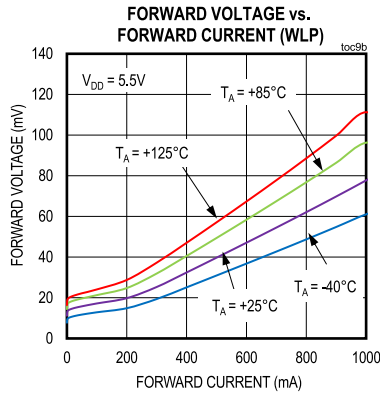
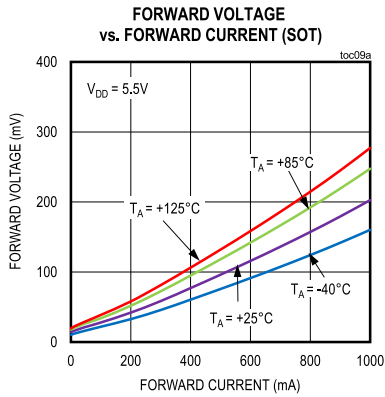
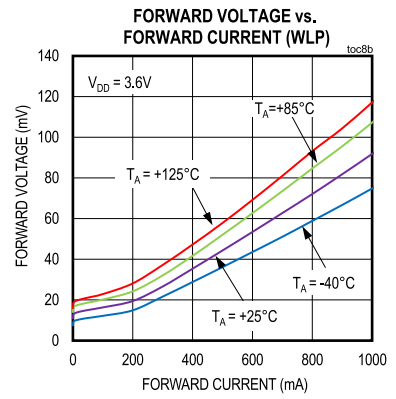
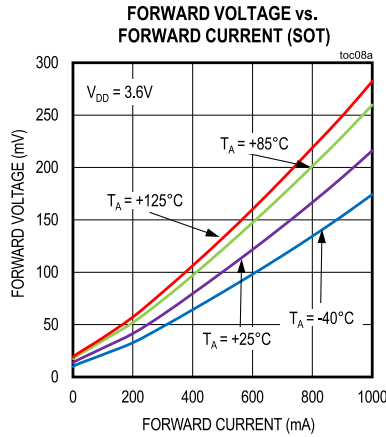
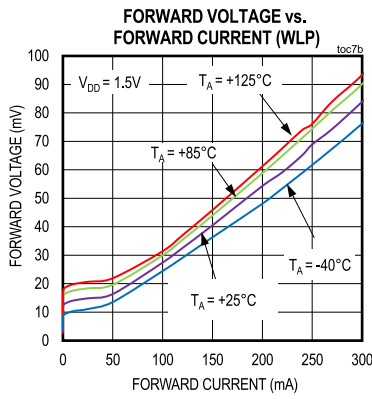

Typical Operating Characteristics (continued)

($V_{DD} = 3.6V$, $GND = 0V$, $EN = V_{DD}$, $I_{LOAD} = 100mA$, $C_{OUT} = 10\mu F$ to GND . Typical values are at $T_A = +25^\circ C$, unless otherwise noted.)

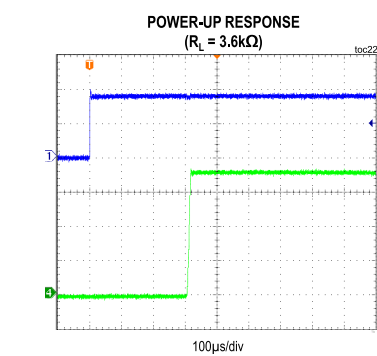
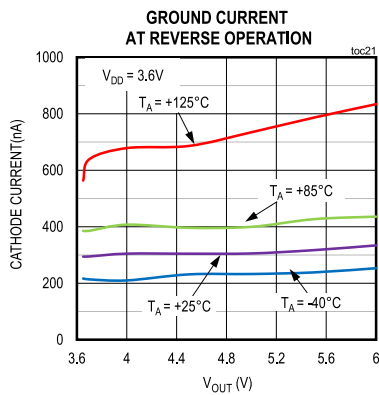
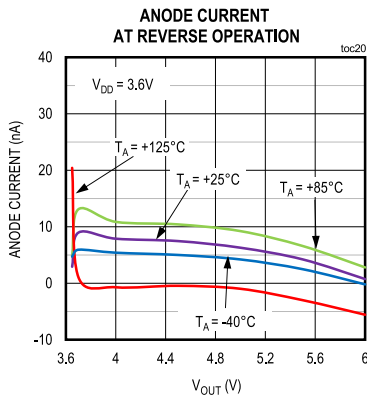
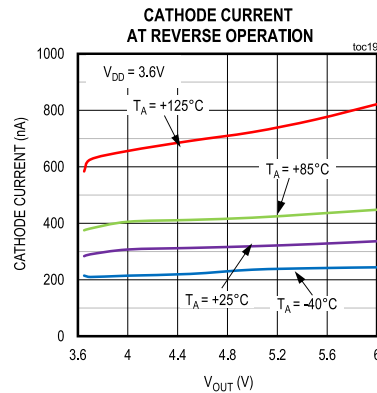
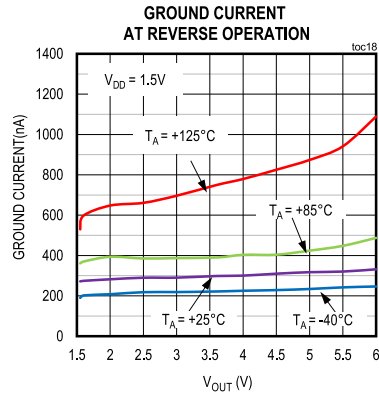
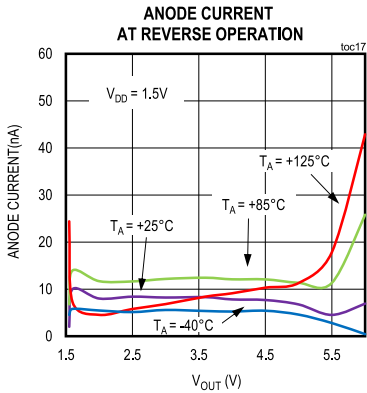
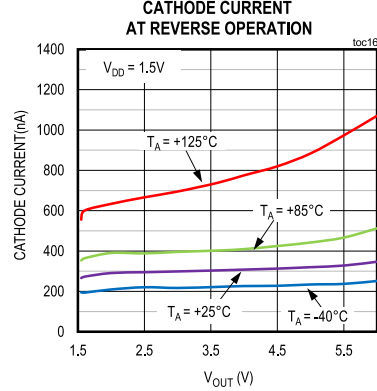
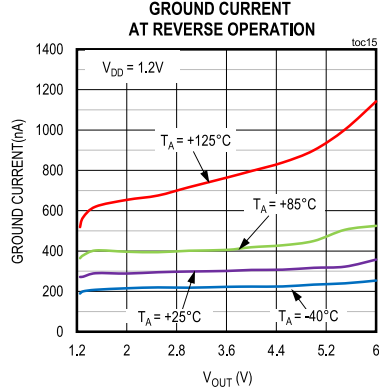
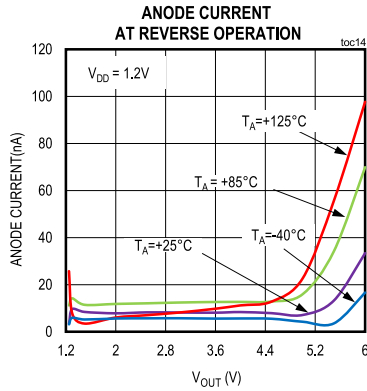

Typical Operating Characteristics (continued)

($V_{DD} = 3.6V$, $GND = 0V$, $EN = V_{DD}$, $I_{LOAD} = 100mA$, $C_{OUT} = 10\mu F$ to GND . Typical values are at $T_A = +25^\circ C$, unless otherwise noted.)

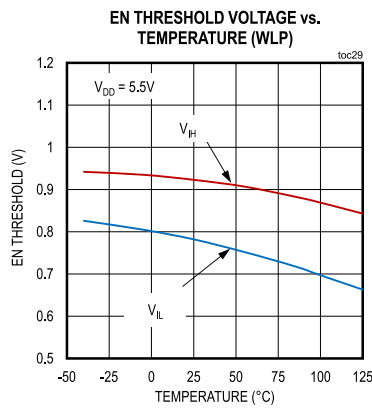
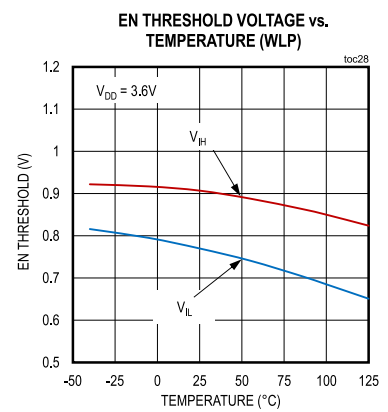
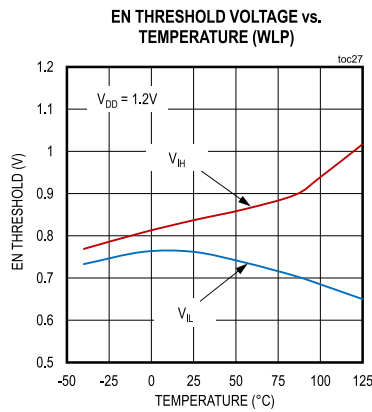
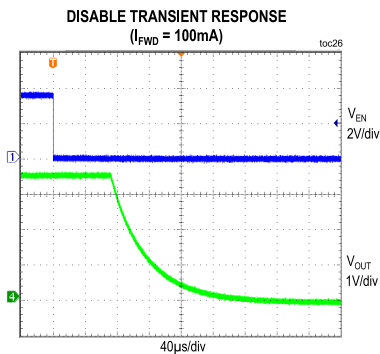
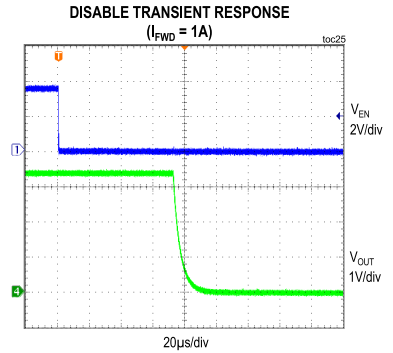
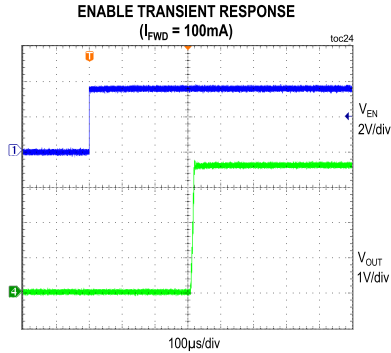
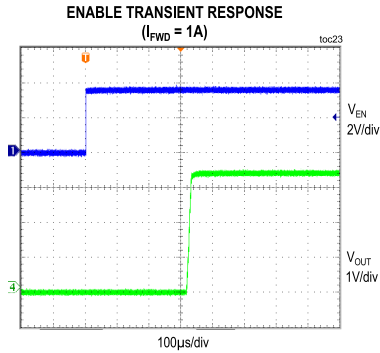

Pin Configuration

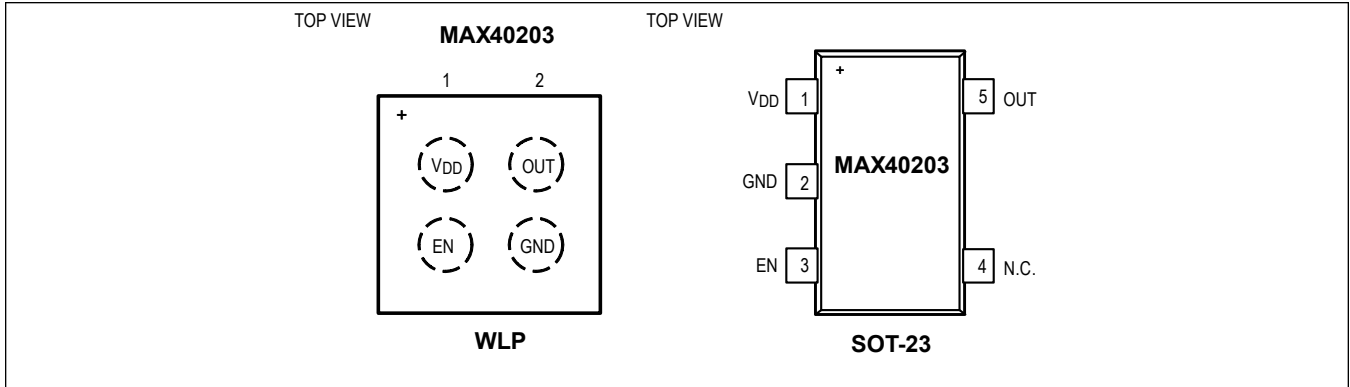

Pin Description

PIN		NAME	FUNCTION
WLP	SOT23		
A1	1	V _{DD}	Input Current (Diode Anode) and Supply Voltage when V _{DD} > V _{OUT}
A2	5	OUT	Current Output (or Diode Cathode). OUT is also the internal supply when V _{OUT} > V _{DD} .
B1	3	EN	Active-High Enable Input with a Weak Internal Pullup. Drive EN high (up to 5.5V regardless of V _{DD}) to enable the device, and pull it low to disable the device. EN must be turned on after V _{DD} is ready.
B2	2	GND	Ground. Power supply return.
-	4	N.C.	No Connection. Not internally connected.

Detailed Description

The MAX40203 mimics a near-ideal diode. The device blocks reverse-voltages and passes current when forward biased just as a conventional discrete diode does. However, instead of a cut-in voltage around 500mV and a logarithmic voltage-current transfer curve, these ideal diodes exhibit a near-constant voltage drop independent of the magnitude of the forward current. This voltage drop is around 43mV at 500mA of forward current.

The near-constant forward voltage drop helps with supply regulation; a conventional diode's voltage drop typically increases by 60mV for every decade change in forward current. Similar to normal diodes, these ideal diodes also become resistive as the forward current exceeds the specified limit (see [Figure 1](#)). Unlike conventional diodes, ideal diodes include automatic thermal protection; if the die temperature exceeds a safe limit, they turn off in order to protect themselves and the circuitry connected to them. Like a conventional diode, the ideal diode turns off when reverse-biased. The turn-on and turn-off times for enable and disable responses are similar to those of forward and reverse-bias conditions.

The MAX40203 features an active-high enable input (EN) that allows the forward current path to be turned off when not required. The device is disabled when EN is low, and the ideal diode blocks voltages on either side to a maximum of 6V above ground. This feature allows these ideal diodes to be used to switch between power supply sources, or to control which sub-systems are to be powered up. The EN input has an internal weak pullup, it can be left open for normal operation (for -40°C to +85°C), or connect to V_{DD} for full temperature operating range. EN should not be turned on before V_{DD} .

It should be noted, however, that these ideal diodes are designed to be used to switch between different DC sources, and not for rectifying AC. In applications where an input voltage that is negative with respect to ground may be applied to the diode, conventional diodes should be used.

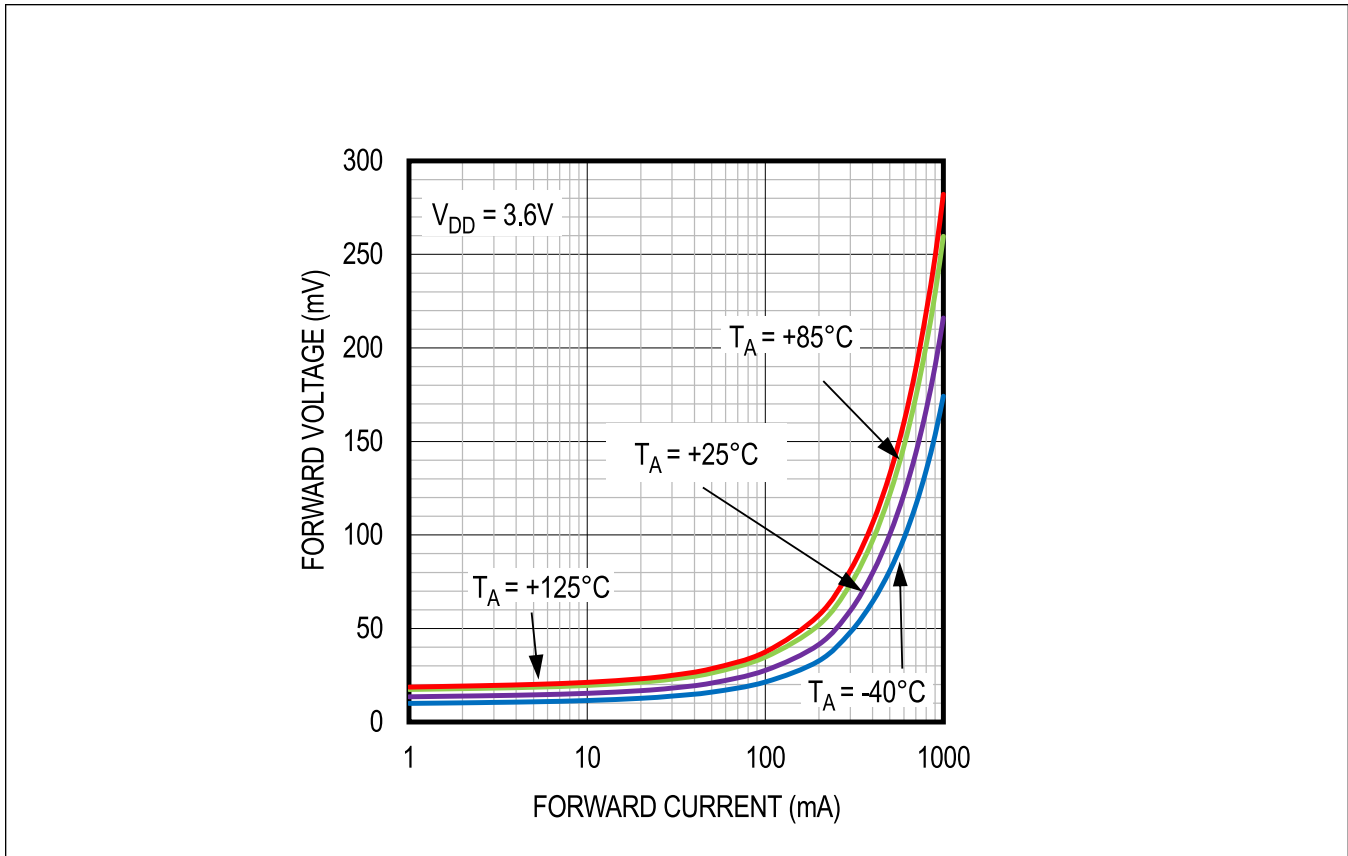

Figure 1. Forward Voltage vs. Forward Current

Principle of Operation

The MAX40203 uses an internal p-channel MOSFET to pass the current from the V_{DD} input to the OUT output. The internal MOSFET is controlled by circuitry that:

1. Switches on the MOSFET (enable input is high), the MAX40203 is forward biased.
2. Turns the MOSFET off when the V_{OUT} is greater than V_{DD} .
3. Turns the MOSFET off if the enable input is pulled low.
4. Turns off the MOSFET when the die temperature exceeds the thermal protection threshold.

Supply and Leakage Current Naming Convention

Figure 2 describes the naming conventions for all the different currents that are specified in the [Electrical Characteristics](#) table.

In forward-biased mode: I_A is the current entering into the V_{DD} pin. I_{AC} is the current entering the V_{DD} pin and exiting from the OUT pin. I_{AG} the current entering the V_{DD} pin and exiting from the GND pin.

$$I_A \text{ (forward biased)} = I_{AG} + I_{AC}$$

Likewise, in reverse-biased mode: I_{CA} is the fraction of the current that enters the OUT pin and exits from the V_{DD} pin. There is also an I_{CG} , in reverse-bias conditions, enters in the OUT pin and exits from the GND pin.

$$I_C \text{ (reverse biased)} = I_{CA} + I_{CG}$$

The supply current is defined as the current entering the V_{DD} pin (I_{AG}), when $V_A \geq V_C$, no load current, and EN is floating. This current all flows to GND.

The leakage current under reverse-biased conditions (I_{CA}) is the current exiting from the V_{DD} pin. This current enters the device from the OUT pin. There is also a current that flows from the OUT pin to the GND pin (I_{CG}). Thus, $I_C = I_{CA} + I_{CG}$. Note that I_{CA} is proportional to the magnitude of the reverse bias. The I_{CG} current is essentially the supply current, it is less sensitive to the magnitude of the reverse bias.

The high input level current, I_{EG} , when $V_{EN} > V_{DD}$ is a current that flows only to GND.

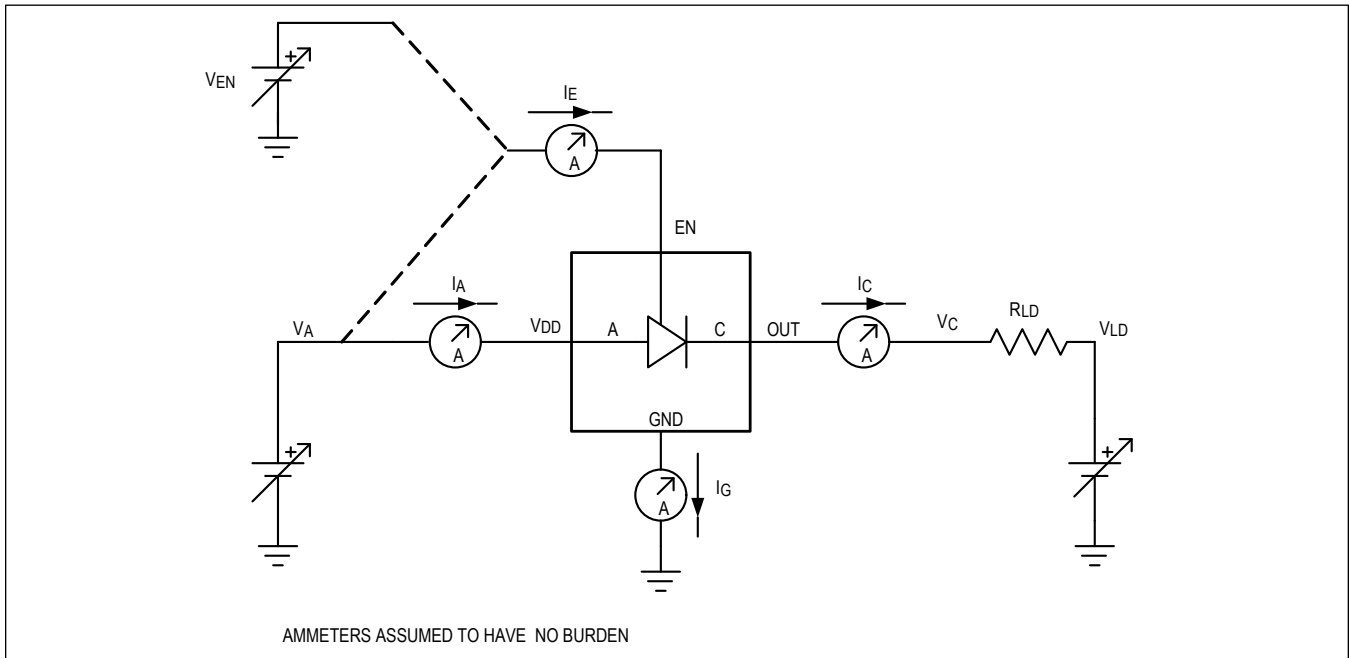

Figure 2. Ideal Diode Test Setup and Naming Convention

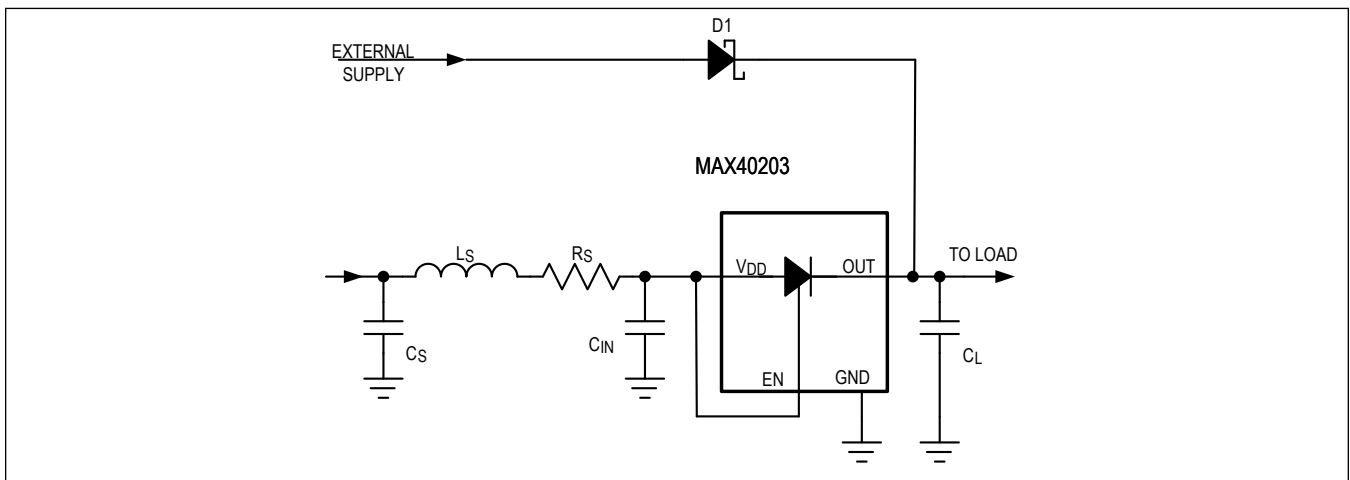

Figure 3. Typical OR Application Showing Source Impedance

Applications Information

Loading Limitations

Due to the very low quiescent current of these ideal diodes, the internal control circuitry has limited response speed. Therefore, when the load contains significant capacitance and currents are high ($> 500\text{mA}$), both the turn-on time and the turn-off time can be noticeable. In most situations this is unlikely to be an issue, but the source impedance needs to be within certain limits if the source voltage is below 2V. This is because a sufficiently large current surge can drop the input voltage to below the minimum supply, causing the internal circuitry to start to shut down.

In [Figure 3](#), the input source inductance and resistance are shown. When a sudden current step occurs, the ideal diode becomes forward biased and turns on, and the resulting current surge causes a momentary drop across L_S and R_S . Placing C_S very close to the V_{DD} pin reduces both L_S and R_S . Adding larger capacitance load is recommended for better load step response.

Thermal Performance and Power Dissipation

The MAX40203 is not designed to operate in continuous thermal fault conditions greater than $+150^\circ\text{C}$. If the junction temperature rises to well above $T_J = +150^\circ\text{C}$, an internal thermal sensor signals the shutdown logic, which turns off the MOSFET, allowing the IC to cool. The thermal sensor turns the MOSFET on again after the IC's junction temperature cools by roughly 14°C . The shutdown logic is intended to protect against short-term transient thermal faults, not continuous over-temperature conditions. A continuous overtemperature condition can result in a cycled output ([Figure 4](#)) with an average temperature greater than $+150^\circ\text{C}$ and should be avoided. During continuous operation, do not exceed the absolute maximum junction temperature rating of $T_J = +150^\circ\text{C}$.

Although the MAX40203's operating range is $-40^\circ\text{C} \leq T_A \leq +125^\circ\text{C}$, care must be taken when using heavy loads (e.g., I_{FWD} above 500mA to 1A). The forward voltage drop across the V_{DD} and OUT pins increases linearly with forward current when the forward current is high. In this resistive region, the dissipation increases with the square of the forward current.

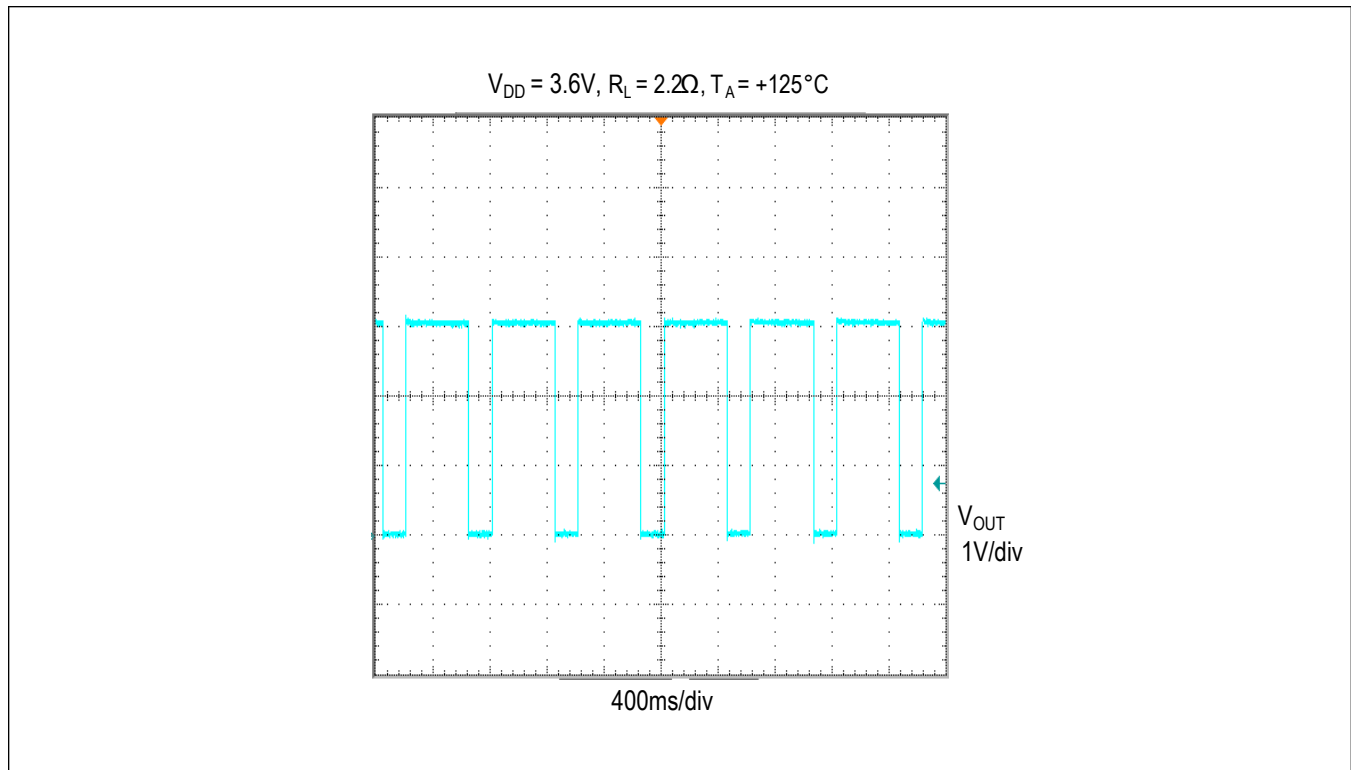

Figure 4. Cycled Output During Continuous Thermal Overload Condition

The power dissipation is the differential voltage (V_{FWD}) multiplied by the current passed by the device (I_{FWD}). The quiescent current has a negligible effect. The ambient temperature is essentially the PCB temperature, since this is where all the heat is sunk to. Therefore, the die temperature rise is $[V_{FWD} \times I_{FWD} \times \theta_{JA}] + T_A$, where T_A is the temperature of the board or ambient temperature.

Example calculations follow for power dissipation and die temperature for the SOT package.

SOT23:

Because the SOT23 package has a higher thermal resistance than the WLP, we'll reduce the forward current by 50%, yielding $I_{FWD} = 500mA$, $V_{FWD} = 175mV$ (maximum value at 500mA), $T_A = +85^\circ C$.

$$P_{DIS} = 500mA \times 175mV = 87.5mW.$$

Package Derate Calculation:

From the Absolute Maximum Ratings, the Maximum Power Dissipation up to $+70^\circ C$ is 312.6mW. At $+85^\circ C$ ambient temperature, the maximum power dissipation is:

$$312.6mW - [(85^\circ C - 70^\circ C) \times 3.9mW/^\circ C] = 253.5mW.$$

The power dissipation determined above is 87.5mW, so it is well within the limit. Note that, due to the SOT23's higher thermal resistance, a continuous forward current of 1A would be above the limit.

The junction temperature is

$$85^\circ C + (87.5mW/3.9mW/^\circ C) = 85^\circ C + 22.4^\circ C = 107.4^\circ C,$$

which is well below the maximum rating.

Note that for $I_{FWD} = 1A$, the worst-case forward voltage increases to 500mV, yielding a power dissipation of 500mW, which is greater than the maximum limit, and would be expected to trip the thermal shutdown.

Typical Application Circuits

Battery and Wall-Adaptor Power ORing

A typical use for an ideal diode is to serve as a diode with very low voltage drop in a simple power supply ORing circuit for portable electronics. The low, <50mV drop is a significant improvement compared to any diode of similar size. In many systems, the wall adapter has sufficient output capability that it can use a standard, cheap diode while the ideal diode is used for the battery circuit. However, an ideal diode can be used for D1 as well to maximize efficiency even when powered from the wall adapter.

The ideal diode has far lower reverse leakage at higher temperatures than typical large Schottky diodes. As a result, the ideal diode can be used with primary cells without danger of damaging them.

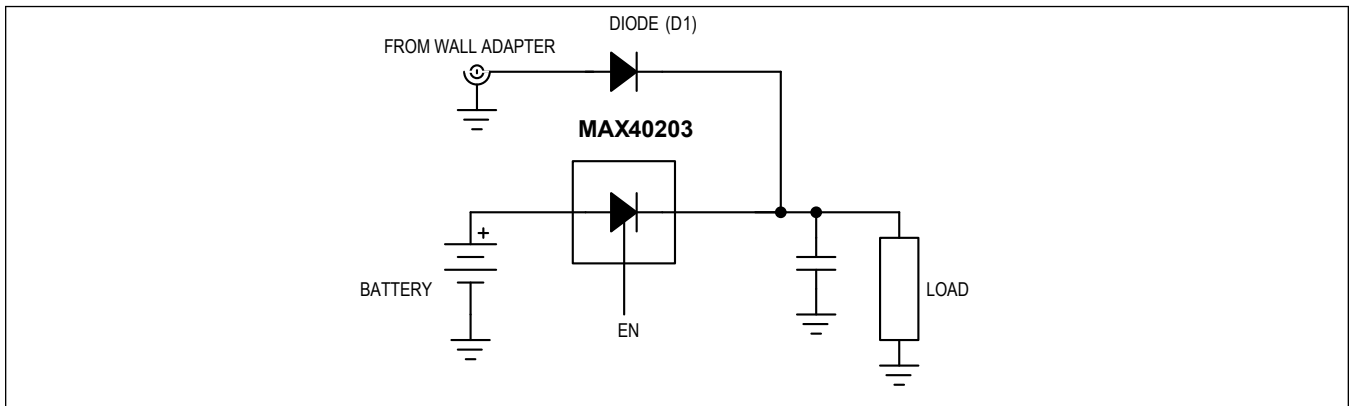

Higher Currents Using Paralleled Ideal Diodes

Since the ideal diode current flows through a MOSFET, placing two or more in parallel will safely increase the current handling capability. This relies on the strong positive temperature coefficient of MOSFETs, so by keeping the paralleled units in close thermal contact, they will inherently share the current.

The following figure shows two units in parallel; this can be extended to multiple units as needed. The upper limit depends on close thermal tracking—up to six units is generally practical when using the WLP versions. If possible, use 2oz copper for the PCB's top metal to help with the thermal connection and keep the units as close together as practical.

Typical Application Circuits (continued)

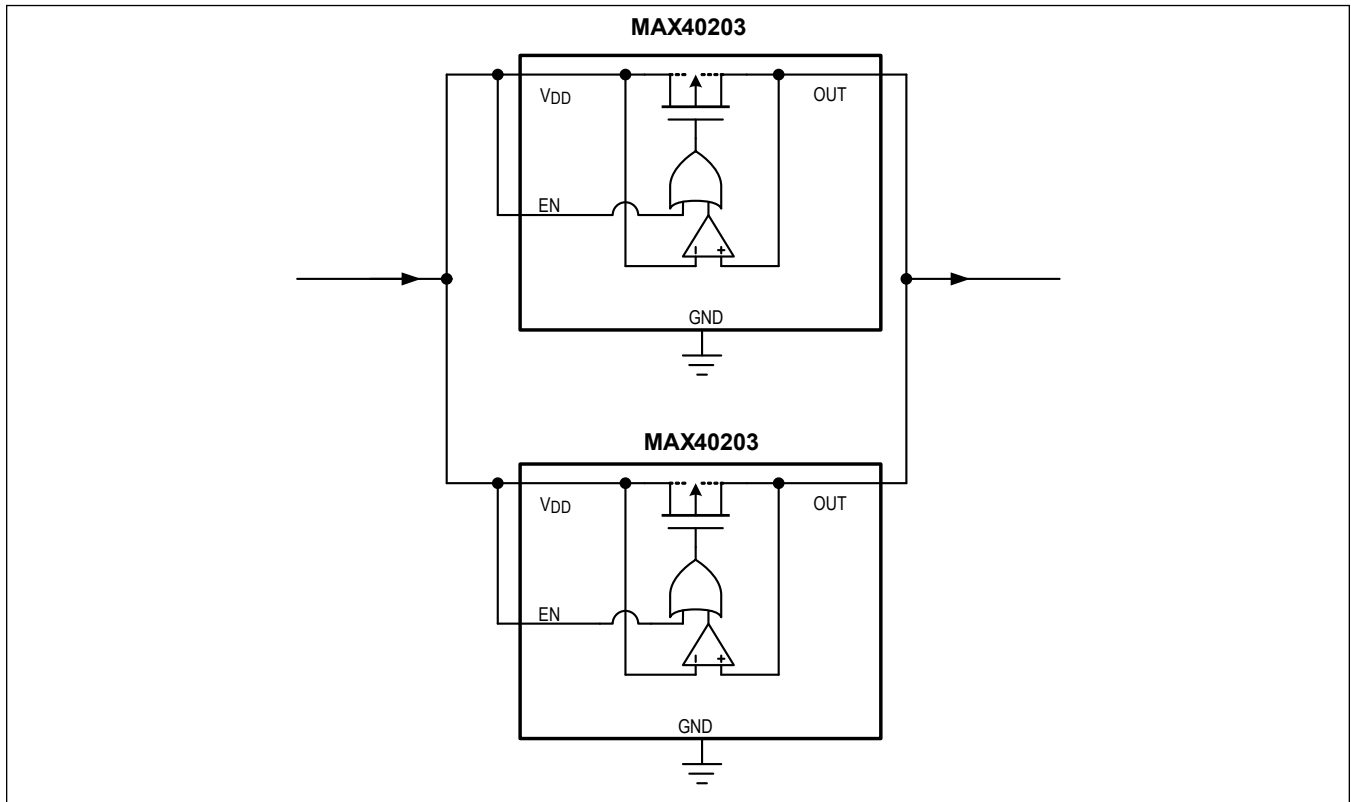

Ordering Information

PART	TEMP RANGE	PIN-PACKAGE	TOP MARK
MAX40203ANS+T	-40°C to +125°C	4 WLP	+H
MAX40203AUK+T	-40°C to +125°C	5 SOT23	AMJO

+ Denotes a lead(Pb)-free/RoHS-compliant package.

T = Tape-and-reel.

Revision History

REVISION NUMBER	REVISION DATE	DESCRIPTION	PAGES CHANGED
0	6/18	Initial release	—
1	3/19	Updated <i>General Description, Benefits and Features, Electrical Characteristics, Typical Operating Characteristics, Detailed Description, and Ordering Information</i>	1, 3, 5, 6, 9, 13
2	1/21	Updated <i>Electrical Characteristics, Typical Operating Characteristics, and Pin Description</i>	3, 8, 9
3	3/21	Adding Package Outline Drawings	3, 4

For pricing, delivery, and ordering information, please visit Maxim Integrated's online storefront at <https://www.maximintegrated.com/en/storefront/storefront.html>.

Maxim Integrated cannot assume responsibility for use of any circuitry other than circuitry entirely embodied in a Maxim Integrated product. No circuit patent licenses are implied. Maxim Integrated reserves the right to change the circuitry and specifications without notice at any time. The parametric values (min and max limits) shown in the Electrical Characteristics table are guaranteed. Other parametric values quoted in this data sheet are provided for guidance.

Mouser Electronics

Authorized Distributor

Click to View Pricing, Inventory, Delivery & Lifecycle Information:

[Analog Devices Inc.:](#)

[MAX40203AUK+](#) [MAX40203AUK+T](#) [MAX40203ANS+T](#)